

# nascom

## Nascom 2 Microcomputer DOCUMENTATION

*The Nascom Microcomputers Division of Lucas Logic Limited reserves the right to amend/delete any specification in this brochure in accordance with future developments.*

*© Copyright Lucas Logic Limited*

**Nascom Microcomputers**  
**Division of Lucas Logic Limited**  
Welton Road Wedgnoek Industrial Estate  
Warwick CV34 5PZ  
Tel: 0926 497733 Telex: 312333

**Lucas Logic**



Section 2 - Construction

<u>Contents</u>		<u>Page</u>
1.	Introduction	2.1
2.	Important notes for construction	2.2
3.	Tools needed	2.3
4.	Preliminary notes	2.3
5.	Assembly procedure	2.4
Appendix 1	Using a multimeter	2.11
Appendix 2	Soldering	2.12
Appendix 3	MOSIC handling precautions	2.13

**INTRODUCTION**

This manual is the assembly guide for the construction of the NASCOM 2. It should be used in conjunction with the Hardware Manual, which contains the component lists, layout diagrams, link options, power supply (PSU) requirements and notes on component identification.

Obviously this manual will be read by purchasers from many varied backgrounds and for this reason it has been written with the needs of the novice constructor in mind - a section on 'how to solder' is included for those of you new to the soldering iron.

The best general advice we can give is:-

TAKE YOUR TIME

CHECK AND DOUBLE CHECK EVERYTHING YOU DO

READ THESE NOTES CAREFULLY

Time spent now can save much effort and frustration later on.

## 2. IMPORTANT NOTES FOR CONSTRUCTORS

1. Do not begin construction now. Read through all the documentation at least twice before starting in order to ensure that no fundamental and expensive errors are made.
2. Do not leave MOS integrated circuits out of their antistatic packing. (See MOS handling instructions in appendix 3 ). If in doubt leave all ICs in their tubes at present.
3. Keep the box in which NASCOM 2 was delivered in case it should have to be returned for repair.
4. Do not attempt to use too large a soldering iron. Utmost care must be taken in soldering as a single dry or unsoldered joint or short circuit can prevent the board from working and can be very difficult to find.
5. Be certain to fit all components on the correct side of the board (the side with the printed information) and to solder them on the other side.
6. Be certain to fit all intergrated circuits, transistors, diodes and tantalm bead electrolytic capacitors in the correct locations and the correct way round. Do not hurry over this. Cross check each time between the components lists and the layout drawing.
7. Be certain to connect the power supplies the right way round and with the correct voltages (otherwise all ICs could be damaged)
8. Do not attempt to remove or plug in intergrated or perform any soldering with the power supplies to the CPU board switched on.
9. If any difficulty is experienced when plugging an IC into its socket do not use extreme force, although the 40 pin ICs, in particular, require quite firm pressure for final insertion, even with all the pins correctly aligned. If in doubt remove the IC;The insertion tool may be found useful. Note that all ICs are manufactured with the leads spread apart by a few degrees to suit mechanised handling equipment. They can be bent parallel with care using small pliers or one row at a time by pressing down sideways with care on a flat surface. There should be no bend in the leads at the point where they narrow down - the full 90 degree bend should occur beside the body of the IC. If care is taken no difficulty will be experienced.
10. Before switching on any supplies, hold board up against a powerful lamp and inspect both sides closely with the magnifying glass for solder splashes, strands of wire, excess solder causing short circuits to nearby tracks, unsoldered joints, incorrectly orientated components and bent IC pins. (To check for the latter look at all ICs end-on)

### TAKE YOUR TIME OVER THIS

11. Do not attempt to work more than 2 or 3 hours at a stretch. A reasonable time for construction would be 30 hours, although it may take from under 10 to 40 hours or more, depending on previous experience. These times are in addition to the initial "reading, considering and inwardly digesting" time, for which at least another 10 hours should be allowed. We repeat that we do not advise construction to begin at all until a few days after receipt of the kit and full reading of the documentation.

### 3. - TOOLS NEEDED

1. Long nose pliers
2. Side cutters
3. Soldering iron/bits. (The maximum bit size advisable for use on the integrated circuits is 1/16" although a 1/8" bit could be used on the component leads). We would recommend the use of two soldering irons or a single 15 watt iron with two interchangeable bits of around 1/32" and 1/16" diameter. (The only combination likely to prove suitable for all purposes would be a thermostatically controlled iron with a tapering bit).
4. A damp sponge or cloth - to keep soldering iron bit clean.
5. A powerful light source - for example, an anglepoise lamp.
6. A magnifying glass - this will prove very useful when inspecting the PCB.
7. A multimeter - not necessary, but useful to check component values and correct polarity of power supplies, etc.

### 4. - PRELIMINARY Notes

1. Unpack the kit and check all the components against the parts list. Return all MOS integrated circuits to their anti-static packing immediately after checking.
2. Inspect the printed circuit board (PCB) and the keyboard (KBD) assembly for any signs of damage.
3. The component side of the double-sided through-hole plated PCB is identified by the silk-screen legend and the number 2 after the words NASCOM 2, etched in the copper cladding. The reverse of this side is where the soldering takes place, and is indicated by the Number 1.
4. All resistors and capacitors (apart from the ten tantalum bead electrolytics), the 4,16 and 26 pin plugs and the crystal may be inserted either way round. The orientation of all other components is VITAL and is indicated by marks on the PCB which are referred to in the next section.
5. The resistors may be prepared for insertion by bending the leads to a separation of  $\frac{1}{2}$ " (12.7mm). The long nosed pliers may be used for this and take care not to bend the leads too close to the component body as damage to the component might result.

Most of the other components will fit directly into the PCB, but some (notably the smaller tantalum capacitors) have a lead separation smaller than the corresponding holes in the PCB. DO NOT use these holes to 'spread' the leads as the component is pushed in (as this could easily cause damage) but bend the leads to fit before insertion.

6. After insertion, components may be held in place prior to soldering, by bending the leads about 40° in opposite directions. Alternatively, insulation tape or a flat board may be used to hold them in place temporarily. On no account should component leads be bent to 90° (flat against the board) as severe damage to the PCB could result if the component is ever removed.

7. When soldering the IC sockets it may be a good idea to solder only two pins on opposite corners to begin with. Then turn the board over again and check that the sockets are flat on the board, straight and also correctly oriented. Any necessary alterations may now be carried out with ease, as only two pins are soldered. If all the pins had been soldered such modifications would range from difficult to nearly impossible- as anyone who has removed a 40 pin IC socket would tell you.
8. After soldering, leads should be cut off about 0.1" (2.5mm) from the underside of the board.

#### 5. Assembly Procedure.

Check off each component on the Component Reference Order list as it is inserted. If no reference is made to the component orientation it is either unambiguous or unimportant.

1. RESISTORS R1 to R86 (Note; Numbers missing from this sequence are: R58, R59, R60, R67 (Except for kits purchased in France); R78, R79, R80) Double check the correct location for each component.
2. DIODES D1 to D8 The orientation for these components is

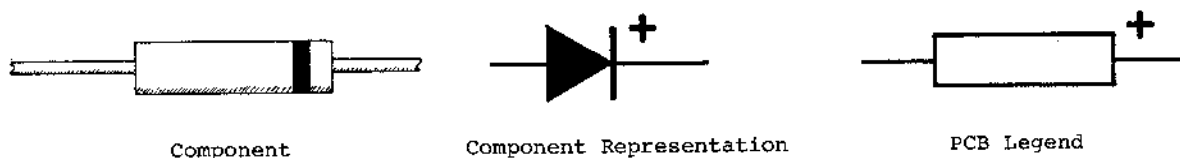

Check orientation carefully.

3. ZENER DIODE ZD1 The orientation for this component is the same as for the diodes above. Note however that the component representation for the Zener diode is

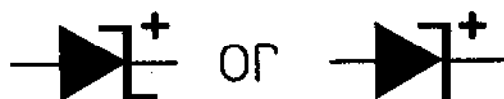

Component Representation

Check orientation carefully.

4. SOLDER POSTS TP1 to TP24 These should be inserted so that the head is on the soldering side of the board. Insertion may require some force, but if difficulty is experienced, remove the post and either file the splines a little or crimp them with pliers. The solder posts should be soldered on both sides of the board in case the through plating was damaged during insertion.

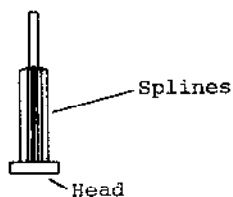

Check orientation carefully.

5. IC SOCKETS Before mounting the sockets, check that no pins are bent or missing. During insertion take care not to bend any pins, and note that the 40 and 24 pin sockets may be a tight fit in the board. Orientation marks are usually placed at one end of the socket to identify the location of pin 1. Some typical marks are shown below. The location of pin 1 on the PCB legend is

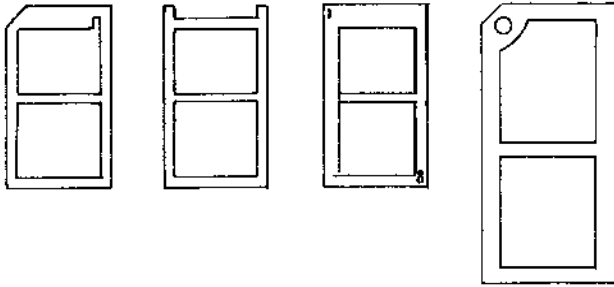
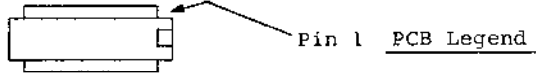

Typical orientation marks; viewed from above, pins facing away from you. Pin 1 is the top left hand corner in each case.

Check orientation carefully.

R87, 820 ohms should now be fitted. This is connected on the reverse (non-component) side of the board connected between pins 6 and 14 of the IC 11 socket. Take care that you fit the resistor between the correct pins, and that the leads do not cause any short circuits

6. POTENTIOMETER VR1

7. LIGHT EMITTING DIODES LED 1 and LED 2 These components should not be flush mounted (unless the component is loose fitting) but should be inserted so that the base of the LED is approximately 1/8" or 3mm from the board. The orientation is shown below

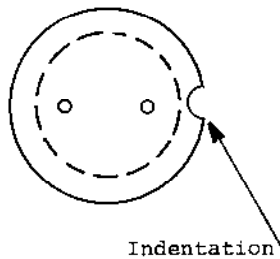

Component

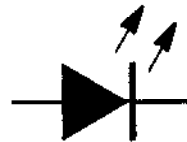
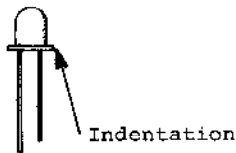

Component Representation

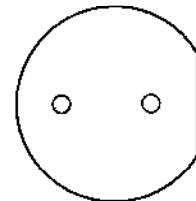

PCB Legend

Check orientation carefully.

8. TRANSISTORS TR1 to TR5 The orientation of these components is

TR1/2/3  
(metal)

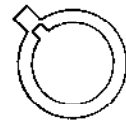
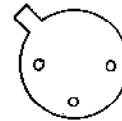
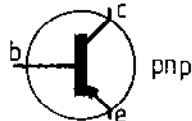
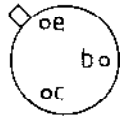

TR1/2/3  
(plastic)

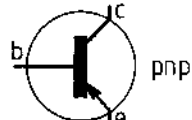
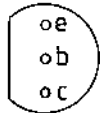

//



TR4

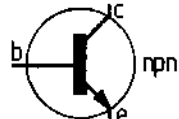
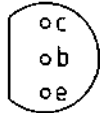

//



TR5

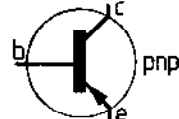
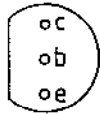

//



Component viewed from BELOW, pins facing towards you

Component Representation

PCB Legend

Component inserted in the PCB, viewed from above.

Check type and orientation carefully.

9. 4 PIN PLUGS LKB1 to LKB9

10. 16 and 26 PIN PLUGS, PL2, 3, 4.

11. TANTALUM CAPACITORS Cs 2,3,4,12,14,18,19,28,29,30.

These are electrolytic capacitors and, as such, must be correctly orientated. The positive (+) terminal is usually indicated in one of 2 ways.

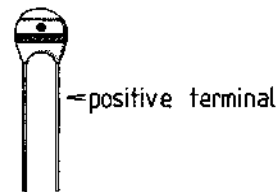
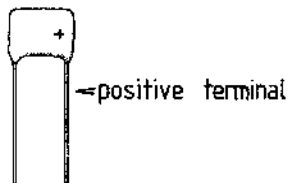

In both cases, the capacitor should be inserted with the +ve terminal adjacent to the + on the PCB legend.

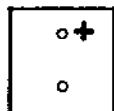

PCB Legend

Check orientation carefully.



12. CERAMIC CAPACITORS C1 - 27, (numbers missing from the sequence are C6, 7, 16, 17, as well as the tantalum capacitors listed above).
13. DECOUPLING CAPACITORS DC1 to DC60 ( . . . These are all 10nF capacitors.
14. 10 WAY SPST DIL SWITCH LSW1 (20 pins) Switch number 0 Should be nearest the edge connector. Wire Links may be provided in place of DIL Switch. The correct connection for these links will be described later.  
Check orientation carefully.
15. 10 WAY SPDT TIL SWITCH LSW2 (30 pins). Wire links may be provided in place of TIL switch. The correct connection for these links will be described later.
16. 16 MHZ CRYSTAL XT1
17. MODULATOR MD1. The modulator should be mounted on the PCB with the phono socket facing away from the 77 way edge connector. (It may require a soldering iron of more than 15 watts to solder the lugs on the base of the modulator to the PCB). The connections to the modulator are

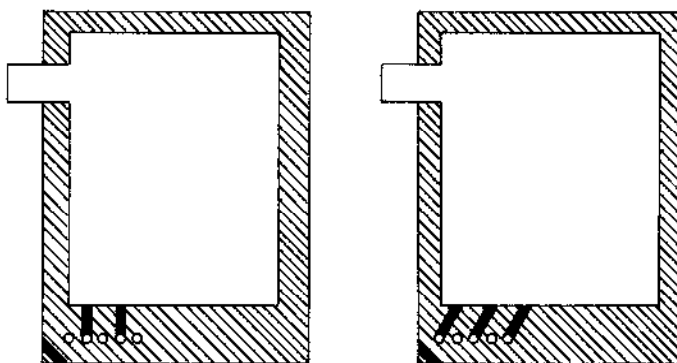

UM111E36 / UM1082A3

UM1231

Viewed from above

Check orientation carefully.

18. RESET SWITCH. Solder the reset switch to the keyboard PCB. (Two plastic lugs on the base of the switch should first be removed with a sharp knife).
19. TV CABLE Make up the interconnection cable for the television with the coax cable, together with the phono and coax plugs provided.
20. IC Insertion ICs should be inserted in the order described.

The following points must be remembered.

- 1). Insert the correct IC with the correct orientation.
- 2). Do not insert any ICs with the power supply switched on - remember to allow several seconds after switching off for the capacitors to discharge.
- 3). Observe the MOS handling precautions.
- 4). If, at any stage, the system does not function on the relevant comments suggested, STOP AT ONCE and SWITCH OFF. Think carefully about what you are doing and refer to the manuals and circuit diagrams. Check again the component locations and orientation, and the position of links and switches. DO NOT PROCEED FURTHER until the problem has been solved. If, at length, you do not achieve success then

you should consult the dealer who should be able to offer a repair service. Alternatively you may be able to obtain assistance from your local Nascom users club.

#### A) Video Section

The notes related to steps 2 - 15 are provided for the benefit of constructors possessing an oscilloscope, frequency meter or possibly a logic probe. The signals indicated may be examined at the relevant points. Remember to turn off the power supply and wait a few seconds (for the capacitors to discharge) before starting on the next step.

Constructors without access to this type of equipment may perform steps 2 - 15 at one go, without switching on and off at each step.

- 1) Tune the TV - see Hardware Manual.
- 2) IC56 (74S04): Enables XTAL Oscillator, 16 MHz, at 56/10 and 49/4. \*
- 3) IC49 (74LS193): 8, 4, 2, 1 MHz @ 49/3 2, 6, 7 resp.  
also 1 MHz at 49/13 driving 51/2 & 52/2
- 4) IC62 - 64 (74LS157), 70 (DP8304)
- 5) IC51 (74LS163) : 62.5 KHz at 51/11
- 6) Switches LSW1/6 & 9 up LSW2/9 down
- 7) IC52 (74LS163) : 15.625 KHz at 52/13
- 8) IC53 (74LS161) : 7.8125 KHz at 53/14 1.116 KHz at 53/11
- 9) IC44 (74LS10) : 50/60 Hz reset at 44/8
- 10) IC55 (74LS13) : 15,625 KHz at 55/6 and 8
- 11) IC60 (74LS00) : 15.623 KHz at 60/3
- 12) IC8 (74LS08) : 15.625 KHz at 8/3 waveform as above
- 13) IC68 (74LS193) : 57 (LS123)
- 14) IC13 (74LS74)
- 15) IC61 (74LS11) : synchs on video o/p
- 16) IC59 (N2V2 PROM) : Plan white rectangle on screen
- 17) IC71 (74LS13)
- 18) IC65 (74LS165) : No CHANGE to display
- 19) IC66 (SY2316B/C28896 Alphanumeric Character Generator) : 16 lines of unstable 00 characters ( )
- 20) IC67 (74LS273) : 16 lines of stable 7F ( ) characters
- 21) IC50 (MK4118) Video RAM : NO CHANGE to display
- 22) IC6 (74LS04) : 16 lines of characters, some or all of which will be random
- 23) IC11 (74LS14), 69 (74LS32)
- 24) IC54 (SY2316B/C28896 Graphics Character Generator) : - optional.  
Switching LSW2/9 UP results in a different display, some characters now being derived from the Graphics Generator.
- 25) IC58 (74LS123) : Anti - 'snow' NO CHANGE to display.

The display section is now complete and construction of the remainder of the system can proceed.

\* IC56 pin 10 and IC49, pin 4; this convention is used throughout.

B) Memory and CPU

The routine below is suitable for the NASCOM 2 in standard configuration. Please refer to the hardware manual for modifications necessary with non-standard configurations.

**Standard Nascom 2 Memory Configuration**

NAS-SYS 1 (Monitor)	0000	-	07FF
VRAM (Video - see video map)	0800	-	0BFF
WRAM(Workspace for monitor,etc).	0C00	-	0FFF
8K Basic	E000	-	FFFF

- 1) LKS 1. Wire the header plug in standard configuration (it is a good idea to insert the header into the socket whilst soldering, in order to keep all the pins steady).

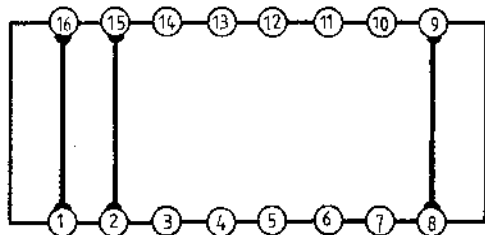

Header, viewed from above.

See hardware manual for non standard configurations.

- 2) Switches LSW1 1-4, 6-9 UP  
 10 DOWN  
 5 X (X means either).
- LSW2 9,10 UP  
 8 DOWN  
 1-7 X

Refer to hardware manual for details

- 3) Links LKB 1-9 Wire all 9 link blocks. The diagram below shows the wiring of 3 linkblocks, the other 6 being exactly the same.

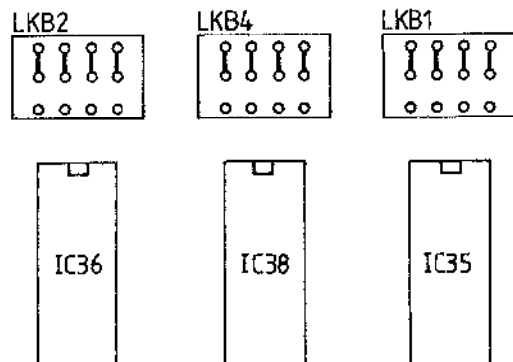

L  
 NB: This wiring applies to 4118 RAMs only, not 2708 EPROMS; see Hardware Manual for further details of alternatives.

- 4) Insert TTL ICs now: ICs 2(74LS257), 3 and 4(81LS95 or 81LS597), 5(DP8304, 7(81LS97), 9(N2DB PROM), 10(74LS32), 12(74LS221), 16(74LS74), 18(7406), 45(DP8304), 46(74LS155), 47(N2MD PROM), 24(74LS378), 25(81LS95 or 97), 26 ( N2IO PROM)
- 5) Insert MOS ICs, observing the handling precautions: 34 (NAS-SYS monitor), 48 (4118 workspace RAM), 1 (Z80-CPU). The system will now produce a display thus:  
  
 NAS-SYS 1  
 — (blinking cursor)
- 6) Plug the keyboard cable into PL3 - NOT PL2 - and ensure correct connection at each end. Keyboard response should now be obtained and the system should act upon keyboard instructions; certain instructions will not function until the board is complete.
- 7) Insert ICs 14, 15 and 17 (74LS74).
- 8) Insert MOS ICs 43(36271 BASIC ROM), 20(6402 UART), 32(4049), 22(4526), 31(4024), 21(4526), 23(4046), 27(4070), 28(4011), 29(4013), 30(4520), 33(4027), 19(3881-4) PIO
- 9) VR1 should now be adjusted with reference to the Hardware Manual.

## HOW TO CONNECT THE KEYBOARD

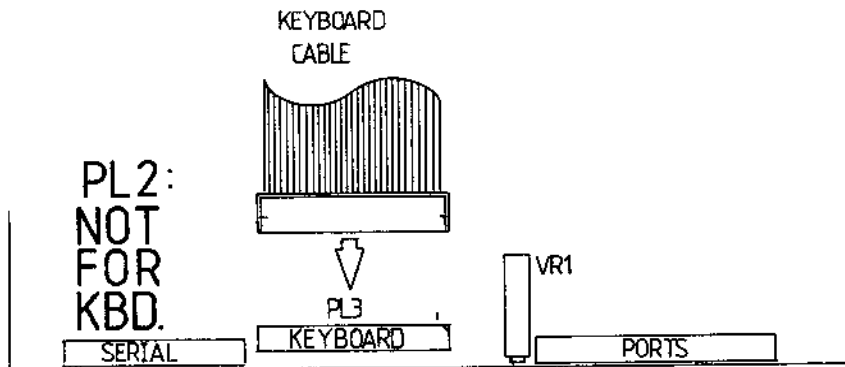

The sockets should be plugged in so that the brown wire on the edge of the 16 way double-ended (sockets at each end) cable is nearest to pin 1. This pin is indicated by a short line across the corner of the processor PCB legend and by the number 1 on the keyboard PCB

(see diagram).

APPENDIX 1 : USING A MULTIMETER

If using a meter to check diode polarity, etc., remember that most multimeters set to an Ohms range produce reverse polarities (from the internal battery) via the test leads. Thus the black lead will be the more positive and current will flow from it to the red lead to measure an external resistance, etc. Therefore, when testing diode or transistor junctions (base and collector or base and emitter) current should flow (giving about  $\frac{1}{2}$  to  $\frac{3}{4}$  scale deflection - the resistance indicated is irrelevant) when the connections are as follows :-

METER :	BLACK LEAD	RED LEAD
Device:- Diode or Zener	ANODE	CATHODE (End with broad ring on body)
LED	ANODE	CATHODE (Shorter lead/indentation in skirt).
NPN Transistor	BASE	EMITTER OR COLLECTOR
PNP Transistor	EMITTER OR COLLECTOR	BASE

With the meter leads reversed from the table, nil or very slight deflection should occur (except for the 3.3 volt Zener which may be seen to conduct appreciably in both directions). In order not to exceed device current or voltage ratings, do not make these tests on the "Ohms x 1" range of any meter. Nor should the highest range of an Avometer be used as the battery produces 15 volts. If you are new to electronics do not be surprised by the orientation of the zener diode in the circuit. In normal operation it is the reverse breakdown property that is used rather than the forward junction conduction, so it may appear to be fitted back to front at first sight.

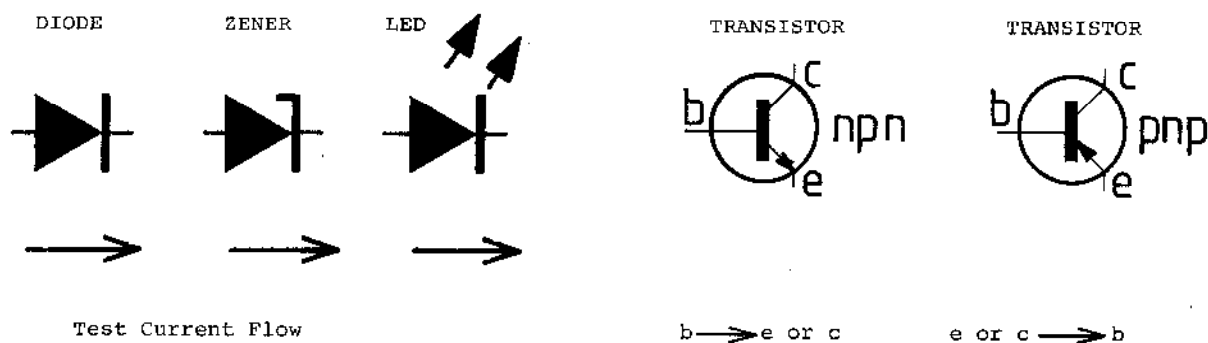

## APPENDIX 2 : SOLDERING

Here are a few hints for those of you who are unaccustomed to using a soldering iron.

- a) Use thin resin-cored solder.
- b) Use a low wattage iron (not more than 15 to 25 watts) with a suitable bit - see assembly guide.
- c) Keep the bit clean with a damp sponge or cloth.
- d) Be sure you are soldering the right component in the right place. To remove an incorrect component first use desoldering braid or a sucker and then great care (so as to avoid lifting the copper tracks off the fibreglass board).
- e) Solder only on the bottom (non-component) side of the board. (Except for the 24 solder posts).
- f) For each joint first apply the iron to the appropriate place, followed immediately by the solder. The solder should melt immediately and enough should be applied to fill the hole and leave a symmetrical conical mound with flat sides, neither concave (too little solder) nor convex (too much), between the tinned copper pad on the circuit board and the component lead. To fill the larger component holes  $\frac{1}{4}$ " or more solder may need to be applied. Do not be concerned about the appearance of the component side of the hole so long as there is no extreme surplus of solder likely to cause a short circuit to adjacent components, etc. To avoid overheating sensitive components 2 to 3 seconds is the longest time that the iron should remain on any one joint. If the result is not correct first time, return to the joint some 15 seconds later. To avoid leaving tails or spikes of solder jutting out from the sides of a joint always remove the solder first and then the iron within a second.
- g) There are about 2000 joints to be soldered on the NASCOM 2 CPU board. Although it is possible to solder several hundred in one hour, do not try to do too many in one go. By taking it easy and doing the work in several batches, fewer (or no) mistakes will be made and the chances of the unit working first time will be greatly enhanced. When tired - STOP.
- h) The other holes in the CPU board are through plated connections and require no action from the constructor.

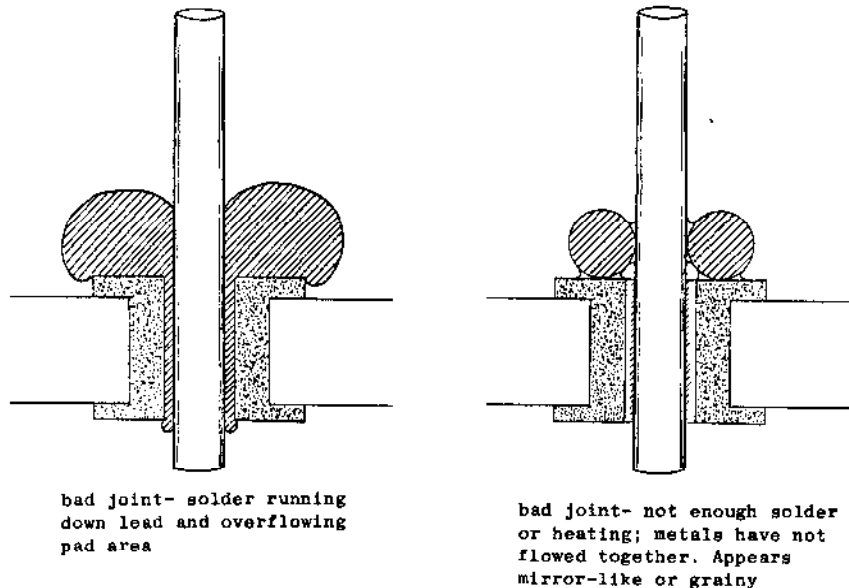
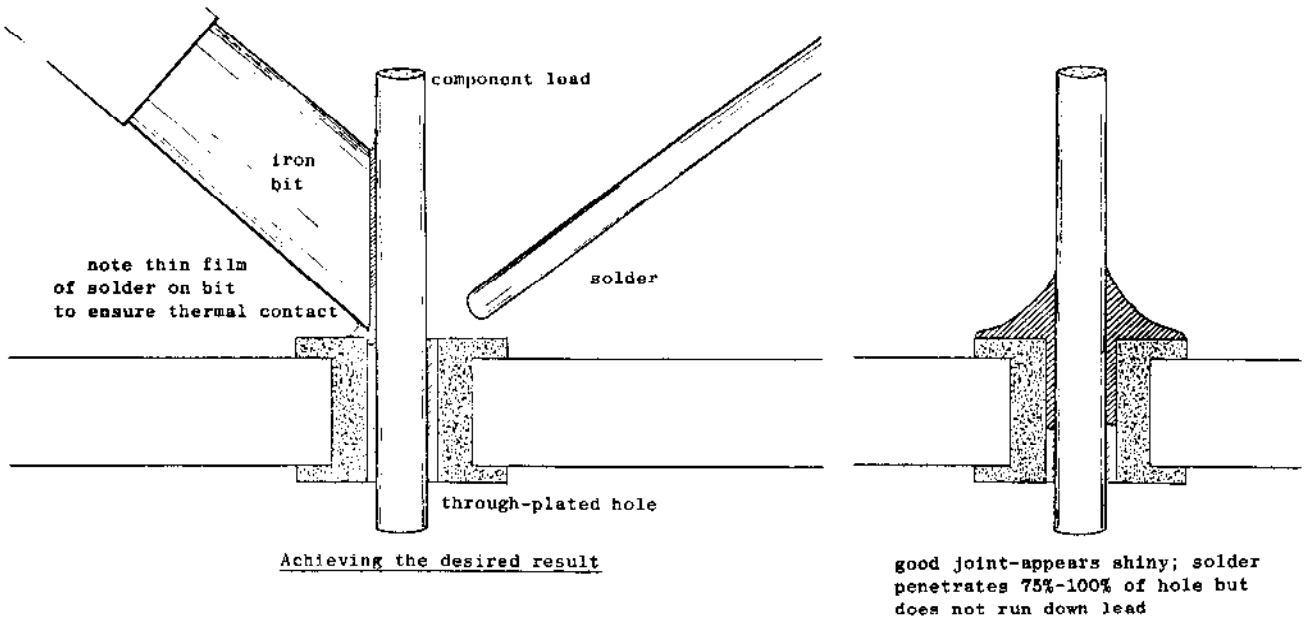

### APPENDIX 3 : MOS IC HANDLING PRECAUTIONS

ICs 1, 19-23, 27-33, 48, 50 and 35-42 (if supplied) are MOS devices in which the gate oxide layer can be destroyed by static electricity discharges with a potential as low as 80 volts. To be on the safe side, we recommend that the following precautions be adopted:

- a) Try not to work in a dry or cold atmosphere that favours the buildup of static electricity.
- b) Avoid wearing silk or nylon clothing.
- c) Connect together the board 0v line, soldering iron body and the mains earth. Also connect this via a 1 megohm resistor to a strap of stripped stranded wire, loosely wrapped around one wrist.
- d) Whenever MOS devices are out of their special packing, but not plugged into the board, work and place them on a conductive sheet such as aluminium foil. Be sure to move away this foil from the underside of the CPU board before switching on any power supplies, however.
- e) Discharge any metal object (with, for example, a damp finger) before bringing it into contact with any of the leads of MOS IC. Remember particularly that this applies to pliers with insulated handles.

### Section 3 Troubleshooting

The Nascom 2 is a well proven product and the user is unlikely to experience any problems. If there is any apparent fault it is always advisable to first check that the various switch and link options are in the correct position - this accounts for many apparent 'faults'.

As with any complex circuit, tracing of genuine faults can be a tricky procedure. Sometimes swapping between components on this board can be used to help to isolate a faulty component. For the average user though the main problem will be lack of familiarity with the circuit and lack of readily available components for swapping. For this reason it is usually advisable to contact your dealer or local user group for advice if you believe you have a fault. Alternatively Nascom offer a repair facility. Price of this service is available on application.

The remainder of this section details areas where problems occur with some regularity. These are usually a result of variation in components obtain from different manufacturers and result in the need for some tuning to improve results.

#### 1. Video circuit tuning.

The use of 74LS13's in IC71 has cured some earlier problems when these components were 74LS20's. However if character distortion or partial loss of characters is experienced an improvement may be affected by connecting a 100pF capacitor from pin 1 to pin 8 of IC65.

#### 2.0 I/O PROM Tuning.

Operation of a serial interface may occasionally exhibit the apparent reading of spurious characters, an effect that may slow down over a period of approximately an hour.

Should this fault occur, 100pF capacitors should be connected in parallel with R45, 46 and 47 (in this order) until the effect ceases.

#### 3.0 DB PROM Tuning

Immediately after execution of a HALT instructions the screen may be blanked, though investigation will reveal unmodified video RAM contents.

On removal of IC58 the screen should immediately return to normal operation. It will, however, fail to suppress flashes caused by repetitive video RAM access.

The flash suppression device may be restored as follows:- Stage 2 should be executed only if the Stage 1 fails to provide adequate suppression, which may be tested using suitable software;

1. Bend pin 9 of IC58 flat; replace IC58 in its socket. Connect a 470R resistor from the pin to the PCB through-plated hole immediately adjacent to, and intersecting the legend of C26.

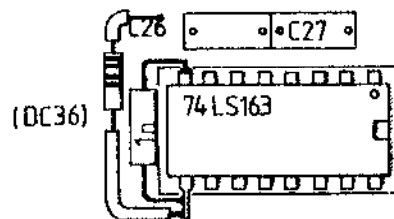

2. Connect a capacitor not more than 1nF between pins 8 and 9 of IC58. Smaller capacitors may provide adequate results.

NB: The execution of a HALT instruction will reveal this fault if it exists, but it is not the only method by which it may be manifest.